

AMY-70-S-C

~18° spot beam. Assembly with holder C compatible with LEDiL HEKLA. Black version.

SPECIFICATION:

Dimensions	Ø 69.9 mm
Height	16.4 mm
Fastening	socket
ROHS compliant	yes ⓘ

MATERIALS:

Component	Type	Material	Colour	Finish
AMY-70-S	Single lens	PMMA		
AMY-70-HLD-C	Holder	PC	black	

ORDERING INFORMATION:



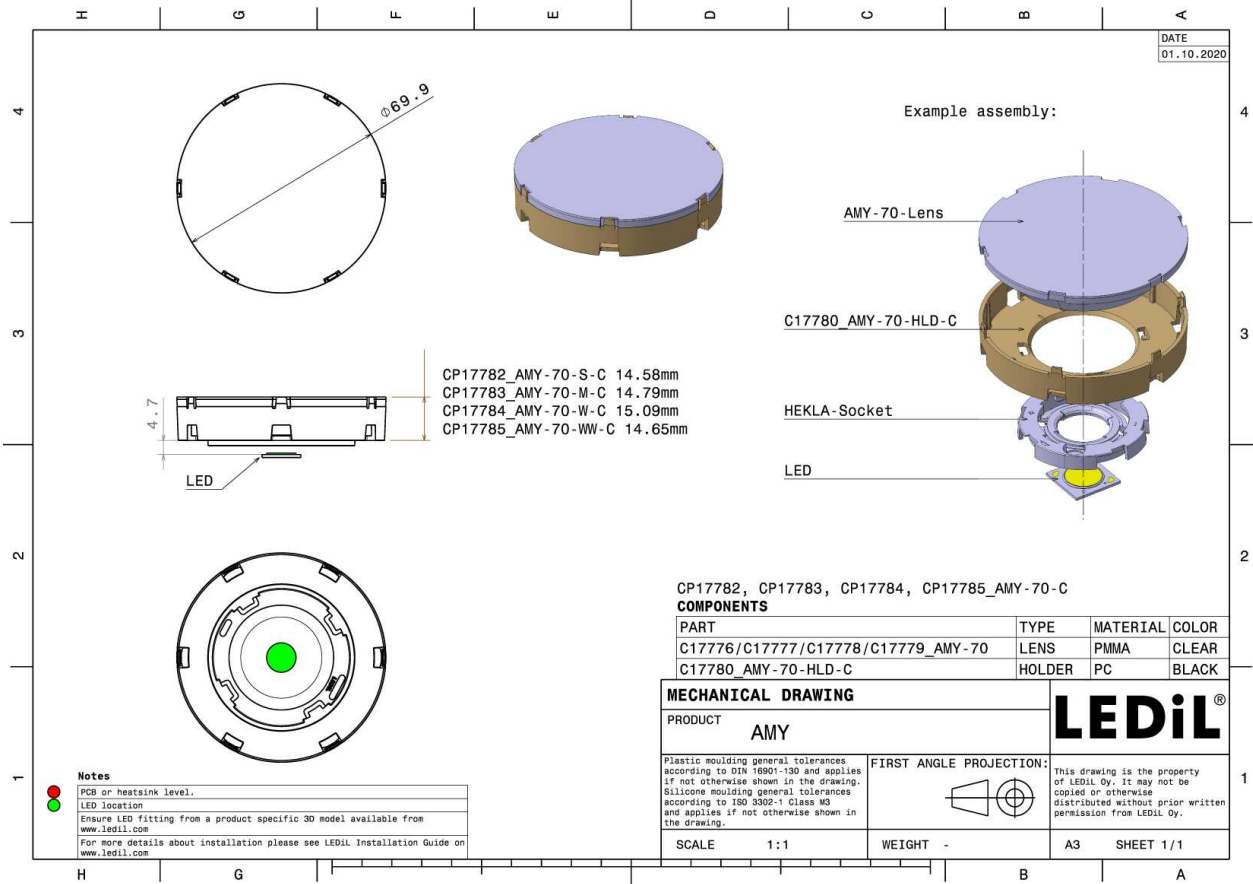

Component	Qty in box	MOQ	MPQ	Box weight (kg)
CP17782_AMY-70-S-C » Box size: 480 x 280 x 300 mm	210	210	15	8.7



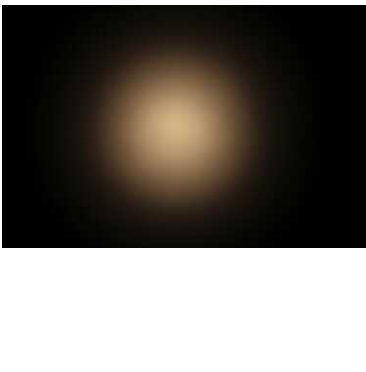
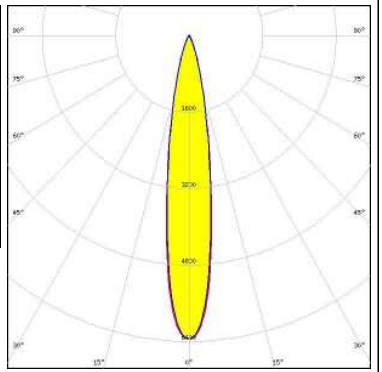

See also our general installation guide: www.ledil.com/installation_guide

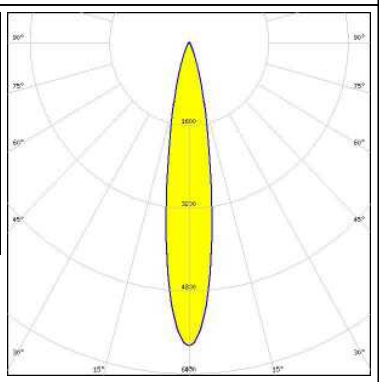
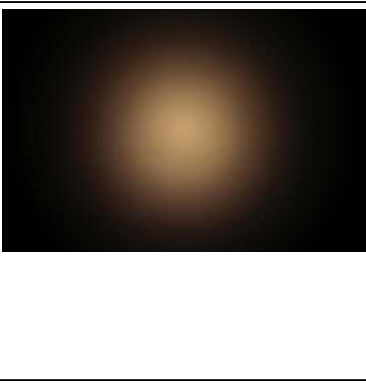
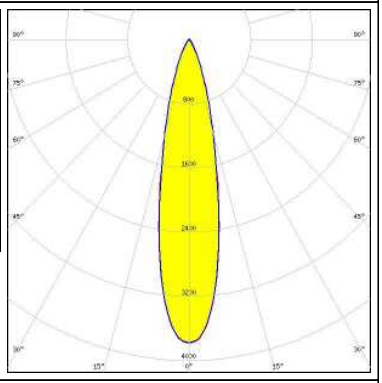
OPTICAL RESULTS (MEASURED):

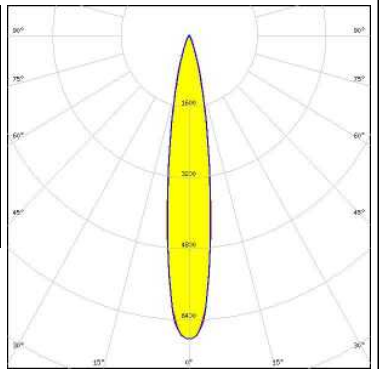
<p>bridgelux.</p> <p>LED V10 Gen 8</p> <p>FWHM / FWTM 17.0° / 37.0°</p> <p>Efficiency 92 %</p> <p>Peak intensity 6.4 cd/m</p> <p>LEDs/each optic 1</p> <p>Light colour White</p> <p>Required components: F15255_HEKLA-SOCKET-C</p>		
<p>bridgelux.</p> <p>LED V11 HD Gen 8</p> <p>FWHM / FWTM 18.0° / 38.0°</p> <p>Efficiency 91 %</p> <p>Peak intensity 5.9 cd/m</p> <p>LEDs/each optic 1</p> <p>Light colour White</p> <p>Required components: Bender Wirth: 633d Hekla</p>		
<p>bridgelux.</p> <p>LED V13 Gen 8</p> <p>FWHM / FWTM 23.0° / 48.0°</p> <p>Efficiency 90 %</p> <p>Peak intensity 3.8 cd/m</p> <p>LEDs/each optic 1</p> <p>Light colour White</p> <p>Required components: F15859_HEKLA-SOCKET-I</p>		
<p>bridgelux.</p> <p>LED V8 Gen 8</p> <p>FWHM / FWTM 17.0° / 36.0°</p> <p>Efficiency 93 %</p> <p>Peak intensity 6.8 cd/m</p> <p>LEDs/each optic 1</p> <p>Light colour White</p> <p>Required components: F15253_HEKLA-SOCKET-A</p>		

OPTICAL RESULTS (MEASURED):

CITIZEN

LED CLL02x/CLU02x (LES10)
 FWHM / FWTM 17.0° / 36.0°
 Efficiency 90 %
 Peak intensity 6.7 cd/lm
 LEDs/each optic 1
 Light colour White
 Required components:
 F17435_HEKLA-G2-C



CREE LED

LED CMU15xx
 FWHM / FWTM 23.0° / 48.0°
 Efficiency 88 %
 Peak intensity 3.7 cd/lm
 LEDs/each optic 1
 Light colour White
 Required components:
 F17438_HEKLA-G2-I

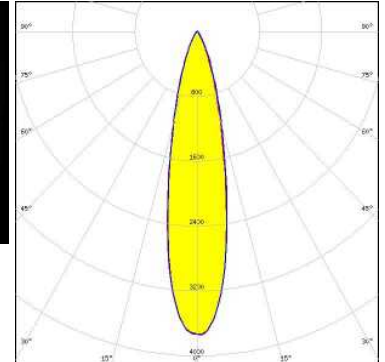

LUMILEDS

LED LUXEON Fusion 12-up (20x24)
 FWHM / FWTM 19.0° / 38.0°
 Efficiency 84 %
 Peak intensity 5.2 cd/lm
 LEDs/each optic 12
 Light colour White
 Required components:
 C16142_HEKLA-SOCKET-K
 F18158_HEKLA-RZ-LENS
 Bender Wirth: 442 Typ L8

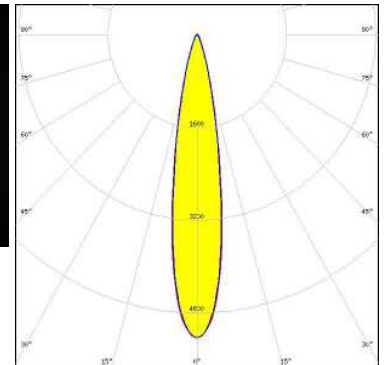
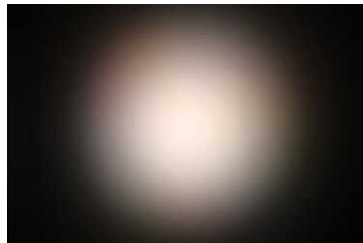



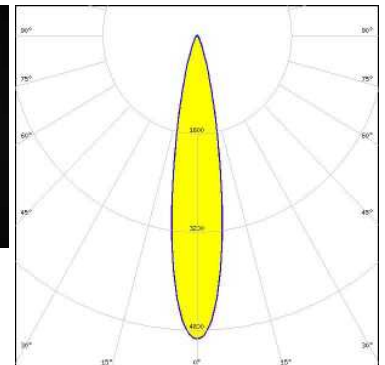
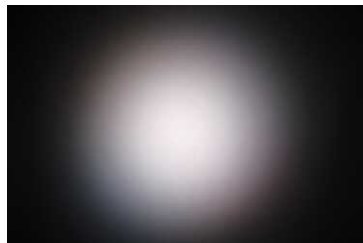

LUMILEDS



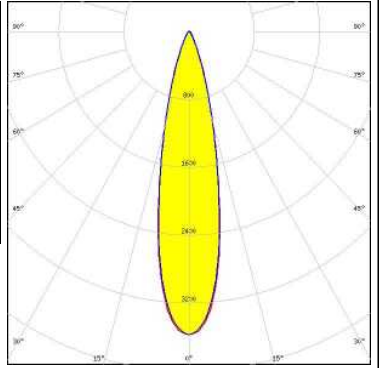

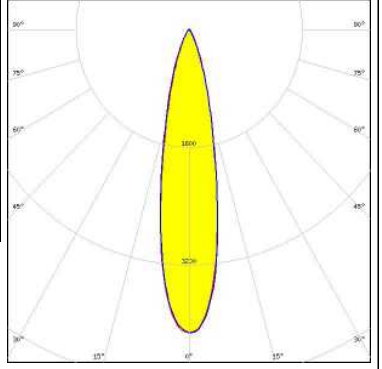

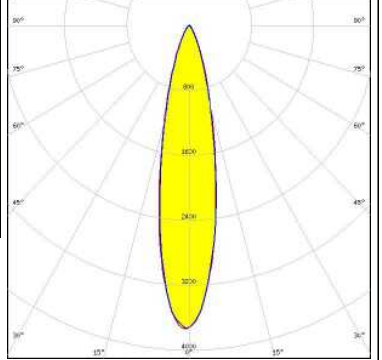
LED LUXEON Fusion 21-up (20x24)
 FWHM / FWTM 19.0° / 38.0°
 Efficiency 82 %
 Peak intensity 4.9 cd/lm
 LEDs/each optic 21
 Light colour White
 Required components:
 C16142_HEKLA-SOCKET-K
 F18158_HEKLA-RZ-LENS
 Bender Wirth: 442 Typ L8



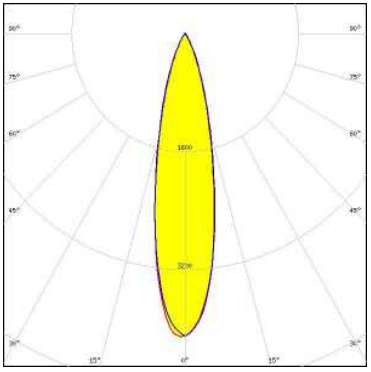

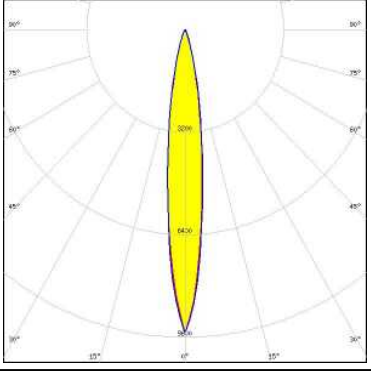
OPTICAL RESULTS (MEASURED):

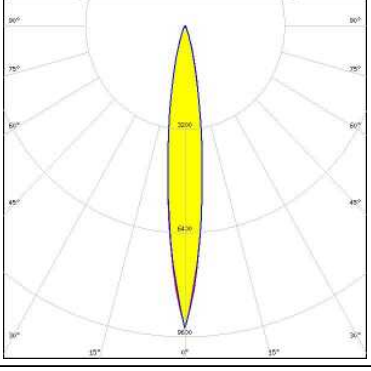
<p>LUMILEDS</p> <p>LED LUXEON Fusion 27-up (20x24)</p> <p>FWHM / FWTM 23.0° / 45.0°</p> <p>Efficiency 82 %</p> <p>Peak intensity 3.6 cd/m</p> <p>LEDs/each optic 27</p> <p>Light colour White</p> <p>Required components: C16142_HEKLA-SOCKET-K F18158_HEKLA-RZ-LENS Bender Wirth: 442 Typ L8</p>		
<p>LUMINUS</p> <p>LED CTM-14 (Tunable White) Gen2</p> <p>FWHM / FWTM 22.0° / 46.0°</p> <p>Efficiency 89 %</p> <p>Peak intensity 4.1 cd/m</p> <p>LEDs/each optic 1</p> <p>Light colour Tunable White</p> <p>Required components: C16142_HEKLA-SOCKET-K Bender Wirth: 442 Typ L8</p>		
<p>SAMSUNG</p> <p>LED LC016D / LC019D / LC026D / LC033D</p> <p>FWHM / FWTM 23.0° / 49.0°</p> <p>Efficiency 88 %</p> <p>Peak intensity 3.7 cd/m</p> <p>LEDs/each optic 1</p> <p>Light colour White</p> <p>Required components:</p>		

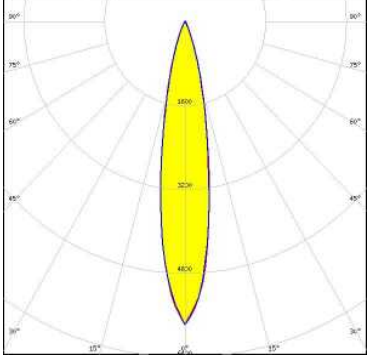
OPTICAL RESULTS (SIMULATED):

<p></p> <p>LED V13 Gen7</p> <p>FWHM / FWTM 23.0° / 48.0°</p> <p>Efficiency 92 %</p> <p>Peak intensity 4.1 cd/lm</p> <p>LEDs/each optic 1</p> <p>Light colour White</p> <p>Required components:</p>	
<p></p> <p>LED V8 Gen7</p> <p>FWHM / FWTM 14.0° / 32.0°</p> <p>Efficiency 91 %</p> <p>Peak intensity 9.5 cd/lm</p> <p>LEDs/each optic 1</p> <p>Light colour White</p> <p>Required components: F15253_HEKLA-SOCKET-A</p>	
<p></p> <p>LED VERO10</p> <p>FWHM / FWTM 14.0° / 32.0°</p> <p>Efficiency 91 %</p> <p>Peak intensity 9.4 cd/lm</p> <p>LEDs/each optic 1</p> <p>Light colour White</p> <p>Required components: F15616_HEKLA-SOCKET-F</p>	
<p></p> <p>LED VERO13</p> <p>FWHM / FWTM 18.0° / 40.0°</p> <p>Efficiency 89 %</p> <p>Peak intensity 5.8 cd/lm</p> <p>LEDs/each optic 1</p> <p>Light colour White</p> <p>Required components: C16142_HEKLA-SOCKET-K</p>	

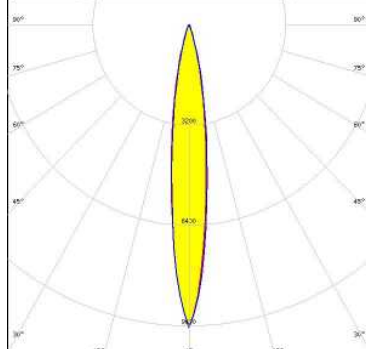
OPTICAL RESULTS (SIMULATED):

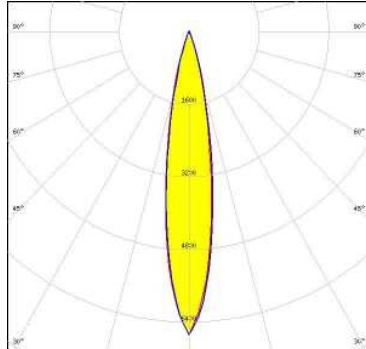
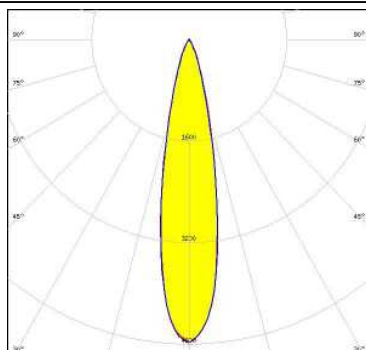
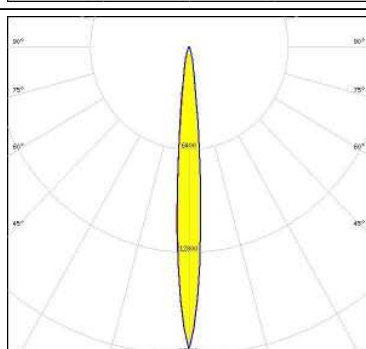
<p></p> <p>LED Vesta DTW 9mm (4W/6W/12W)</p> <p>FWHM / FWTM 14.0° / 32.0°</p> <p>Efficiency 91 %</p> <p>Peak intensity 9.7 cd/lm</p> <p>LEDs/each optic 1</p> <p>Light colour White</p> <p>Required components: Bender Wirth: 652b Hekla</p>	
<p></p> <p>LED Vesta DTW 9mm (4W/6W/12W)</p> <p>FWHM / FWTM 18.0° / 36.0°</p> <p>Efficiency 87 %</p> <p>Peak intensity 6.7 cd/lm</p> <p>LEDs/each optic 1</p> <p>Light colour White</p> <p>Required components: F18158_HEKLA-RZ-LENS Bender Wirth: 652b Hekla</p>	
<p>CITIZEN</p> <p>LED CLL03x/CLU03x</p> <p>FWHM / FWTM 22.0° / 42.0°</p> <p>Efficiency 89 %</p> <p>Peak intensity 4.8 cd/lm</p> <p>LEDs/each optic 1</p> <p>Light colour White</p> <p>Required components: F15859_HEKLA-SOCKET-I</p>	
<p>CITIZEN</p> <p>LED CLU700/701/702/703</p> <p>FWHM / FWTM 10.0° / 20.0°</p> <p>Efficiency 93 %</p> <p>Peak intensity 18.9 cd/lm</p> <p>LEDs/each optic 1</p> <p>Light colour White</p> <p>Required components: F15255_HEKLA-SOCKET-C</p>	

OPTICAL RESULTS (SIMULATED):

CITIZEN

LED CLU700/701/702/703
 FWHM / FWTM 10.0° / 22.0°
 Efficiency 92 %
 Peak intensity 17.2 cd/lm
 LEDs/each optic 1
 Light colour White
 Required components:
 F15255_HEKLA-SOCKET-C



LED CMA1825
 FWHM / FWTM 18.0° / 41.0°
 Efficiency 90 %
 Peak intensity 5.8 cd/lm
 LEDs/each optic 1
 Light colour White
 Required components:
 F15254_HEKLA-SOCKET-B

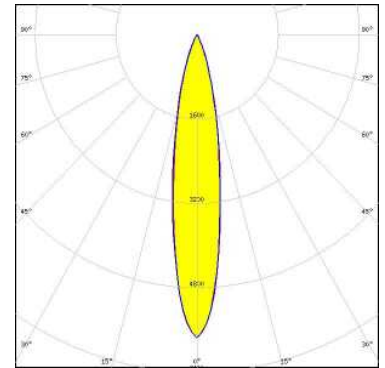

LED CMA1840
 FWHM / FWTM 21.0° / 45.0°
 Efficiency 89 %
 Peak intensity 4.6 cd/lm
 LEDs/each optic 1
 Light colour White
 Required components:
 Bender Wirth: 637a Hekla

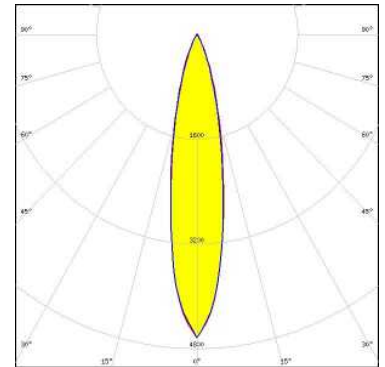

LED CMT14xx
 FWHM / FWTM 15.0° / 34.0°
 Efficiency 91 %
 Peak intensity 8.6 cd/lm
 LEDs/each optic 1
 Light colour White
 Required components:
 F17435_HEKLA-G2-C

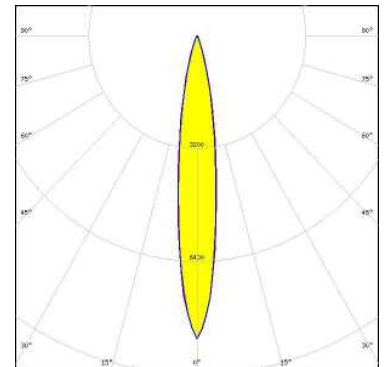

OPTICAL RESULTS (SIMULATED):

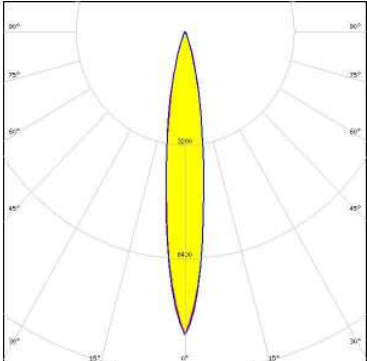
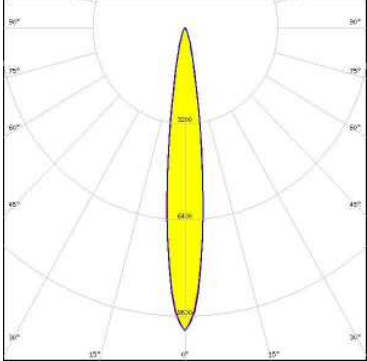
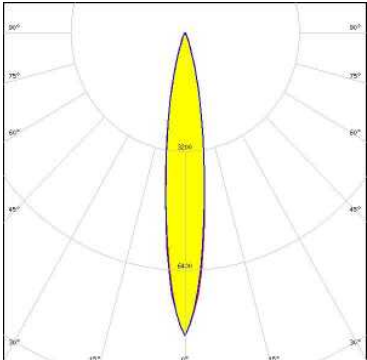
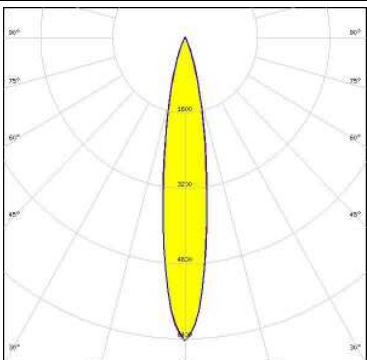
<p>CREE LED</p> <p>LED: CMU10xx FWHM / FWTM: 14.0° / 34.0° Efficiency: 91 % Peak intensity: 8.6 cd/lm LEDs/each optic: 1 Light colour: White Required components: F17435_HEKLA-G2-C</p>	
<p>CREE LED</p> <p>LED: CXA/B 15xx FWHM / FWTM: 14.0° / 29.0° Efficiency: 91 % Peak intensity: 10.1 cd/lm LEDs/each optic: 1 Light colour: White Required components: F15256_HEKLA-SOCKET-D</p>	
<p>LUMILEDS</p> <p>LED: LUXEON CX Plus CoB - HD S04H9 FWHM / FWTM: 16.0° / 34.0° Efficiency: 91 % Peak intensity: 8.2 cd/lm LEDs/each optic: 1 Light colour: White Required components: F15255_HEKLA-SOCKET-C</p>	
<p>NICHIA</p> <p>LED: COB L-Type (LES 11) FWHM / FWTM: 18.0° / 38.0° Efficiency: 90 % Peak intensity: 6.4 cd/lm LEDs/each optic: 1 Light colour: White Required components: F17437_HEKLA-G2-H</p>	

OPTICAL RESULTS (SIMULATED):

PHILIPS

LED Fortimo SLM L15 CoB
 FWHM / FWTM 22.0° / 44.0°
 Efficiency 90 %
 Peak intensity 4.5 cd/lm
 LEDs/each optic 1
 Light colour White
 Required components:
 Bender Wirth: 632a Hekla XL

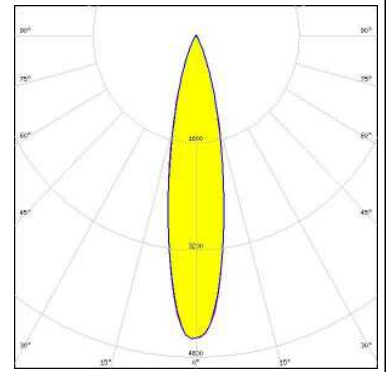

SAMSUNG

LED LC003D / LC006D / LC009D / LC013D
 FWHM / FWTM 14.0° / 30.0°
 Efficiency 92 %
 Peak intensity 10 cd/lm
 LEDs/each optic 1
 Light colour White
 Required components:
 F15255_HEKLA-SOCKET-C

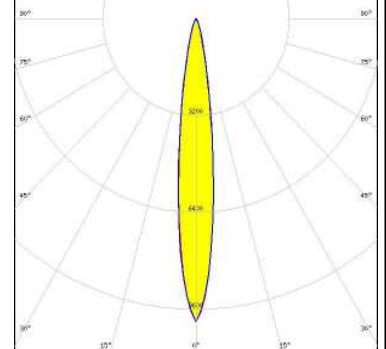

SAMSUNG

LED LC016D / LC019D / LC026D / LC033D
 FWHM / FWTM 22.0° / 44.0°
 Efficiency 89 %
 Peak intensity 4.6 cd/lm
 LEDs/each optic 1
 Light colour White
 Required components:
 F15859_HEKLA-SOCKET-I

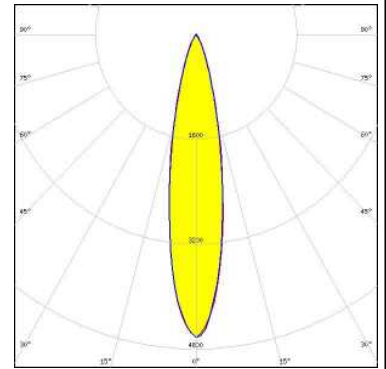

SAMSUNG

LED LC020T (Tunable white)
 FWHM / FWTM 16.0° / 34.0°
 Efficiency 91 %
 Peak intensity 7.4 cd/lm
 LEDs/each optic 1
 Light colour White
 Required components:
 F15859_HEKLA-SOCKET-I

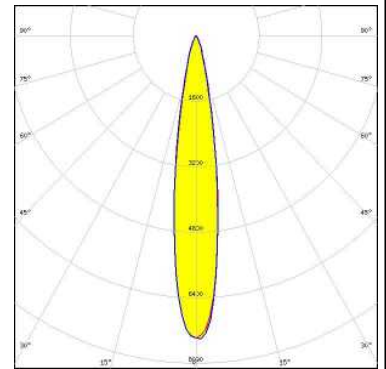

OPTICAL RESULTS (SIMULATED):

XICATO

LED	XOB 14.5 mm
FWHM / FWTM	22.0° / 42.0°
Efficiency	82 %
Peak intensity	4.6 cd/lm
LEDs/each optic	1
Light colour	White
Required components:	
	F17438_HEKLA-G2-I

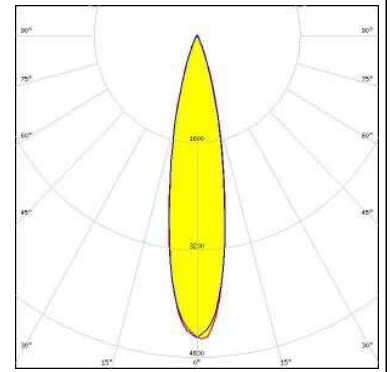

GENERAL INFORMATION:

NOTE: The typical beam angle will be changed by different color, chip size and chip position tolerance. The typical total beam angle is the full angle measured where the luminous intensity is half of the peak value.

Due to use of high power COB's with this product, special attention to proper thermal design is highly recommended. LEDiL has no liability for direct, indirect or consecutive damages arising from the LEDiL products being used outside of the recommended temperature range.

MATERIALS:

As part of our continuous research and improvement processes, and to ensure the best possible quality and availability of our products, LEDiL reserves the right to change material grades without notice.

PRODUCT DATA USER AGREEMENT AND DISCLAIMER:

The measured data in the provided downloadable LEDiL Product Datasheets and Mechanical 2D-Drawings is rounded and provided as reference for planning. LEDiL Oy's optical specifications have been verified by conducting performance testing of the products in accordance with the company's quality system. The reported data are averaged results of multiple measurements with typical variation. LEDiL Oy reserves the right to without prior notification make changes and improvements to its products.

LEDiL Oy assumes neither warranty, nor guarantee nor any other liability of any kind for the contents and correctness of the provided data. The provided data has been generated with highest diligence but the provided data may in reality not represent the complete possible variation range of all intrinsic parameters. Therefore, in certain cases a deviation from the provided data could occur.

LEDiL Oy reserves the right to undertake technical changes of its products without further notification which could lead to changes in the provided data. LEDiL Oy assumes no liability of any kind for the possible deviation from any provided data or any other damage resulting from the usage of the provided data.

The user agrees to this disclaimer and user agreement with the download or usage of the provided files.

LEDiL Oy

Joensuunkatu 13
FI-24240 SALO
Finland

LEDiL Inc.

228 West Page Street
Suite D
Sycamore IL 60178
USA

Ledil Optics Technology (Shenzhen) Co., Ltd.

405 , Block B
Casic Motor Building
Shenzhen 518057
P.R.CHINA

Local sales and technical support

[www.ledil.com/
where_to_buy](http://www.ledil.com/where_to_buy)

Shipping locations

Salo, Finland
Hong Kong, China

Distribution Partners

[www.ledil.com/
where_to_buy](http://www.ledil.com/where_to_buy)